

Rev	Description	By	Date
1	Preliminary	TM	29-Sep-20

ELECTRICAL SPECIFICATIONS @ 25°C

L(per wdg): 950μH Min @ 10kHz, 0.1Vrms
 DCR(per wdg): 6.0mΩ Max
 Irms: ΔT≤40°C @12A
 Turns Ratio: 1:1:1±0T
 (1-2):(3-4):(5-6)
 Polarity: 1, 3 and 5 are in phase
 Hipot: 2kVac, 1mA Max, 10s (wdg to wdg)
 Operating Temperature: -40 °C to +125 °C
 RoHS Compliant: Yes

DIMENSIONS

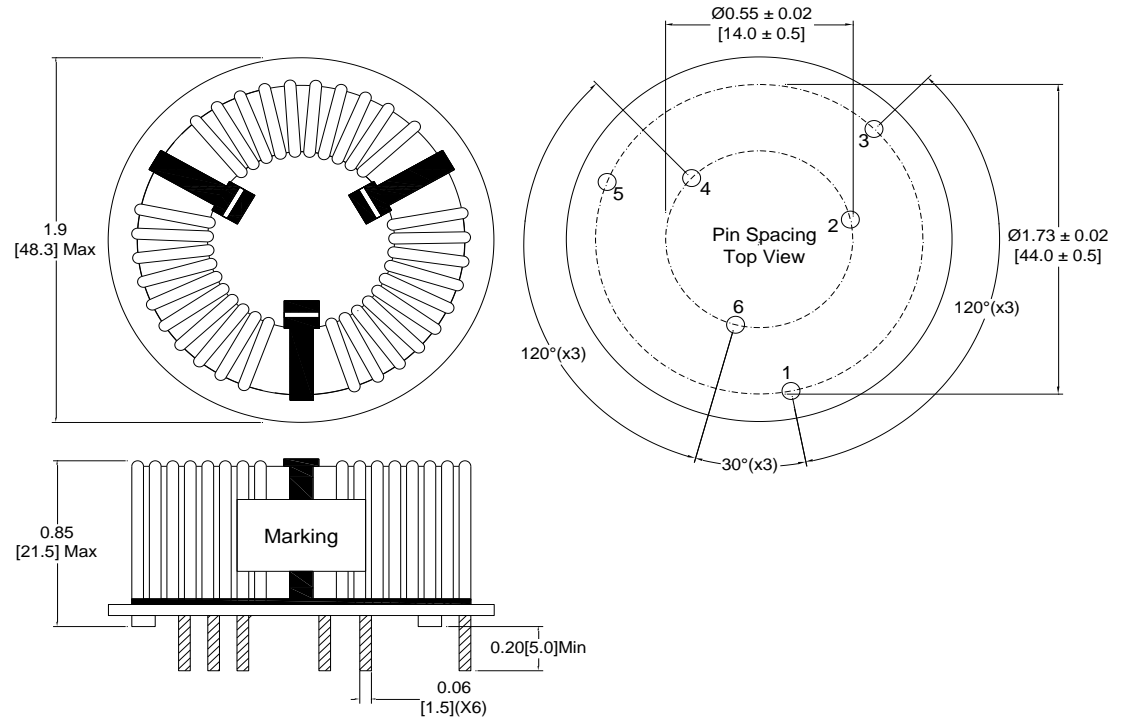

SCHEMATIC

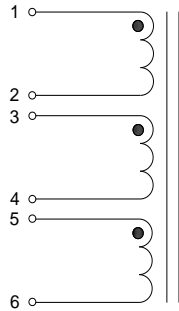

MARKING

MPS
 P56TP38H-951_Rev
 Date Code

Dimensions: inch/[mm]

Notice of Proprietary Property

These drawings and specifications are the property of MPS and shall not be reproduced, copied or used as the basis of manufacture of sale of apparatus without express written authorization



MPS INDUSTRIES, INC.

www.mpsind.com

Tel: (310) 325-1043 Fax: (310) 325-1044

Description

3-Phase CMC

Dimensions Unless otherwise specified .XX ± .010" [0,254mm] .XXX ± .005" [0,13mm]	DRAWN BY: CHECKED BY:	TM AG	29-Sep-20 5-Oct-20	SIZE A	Part Number P56TP38H-951	REV 1
WEIGHT: 90 gms					SHEET: 1 OF 1	