

Rev	Description	By	Date
1	Preliminary	TM	14-Oct-20

ELECTRICAL SPECIFICATIONS @ 25°C

L(per wdg): 3.3mH Min @ 10kHz, 0.1Vrms
 DCR(per wdg): 5.0mΩ Max
 Irms: ΔT≤40°C @ 20A
 Turns Ratio: 1:1:1±0T
 (1-2):(3-4):(5-6)
 Polarity: 1, 3 and 5 are in phase
 Hipot: 2kVac, 1mA Max, 10s (wdg to wdg)
 Operating Temperature: -40 °C to +125 °C
 RoHS Compliant: Yes

DIMENSIONS

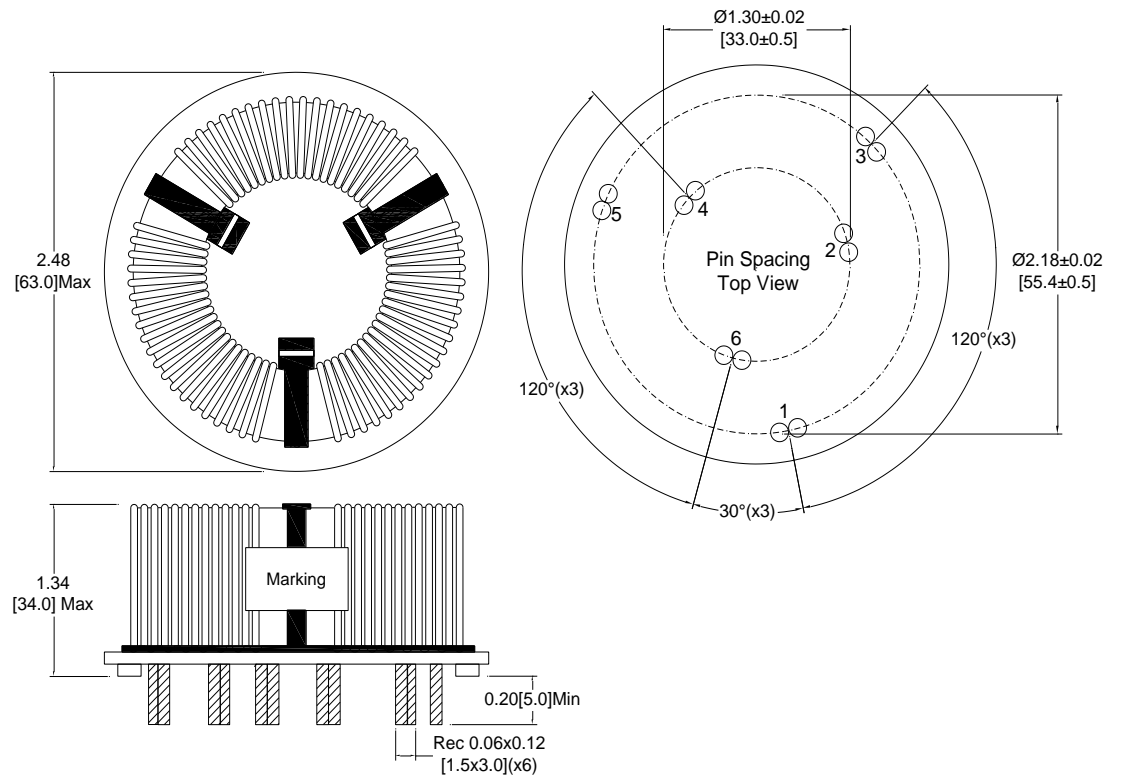

SCHEMATIC

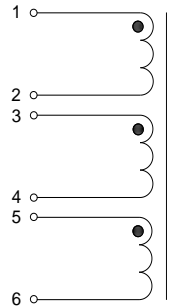

MARKING

MPS
 P57TP50H-332_Rev
 Date Code

Dimensions: inch/[mm]

Notice of Proprietary Property

These drawings and specifications are the property of MPS and shall not be reproduced, copied or used as the basis of manufacture of sale of apparatus without express written authorization

Dimensions Unless otherwise specified .XX ± .010" [0,254mm] .XXX ± .005" [0,13mm]	DRAWN BY: CHECKED BY:	TM AG	14-Oct-20 27-Oct-20	SIZE A
---	--------------------------	----------	------------------------	------------------



MPS INDUSTRIES, INC.

www.mpsind.com

Tel: (310) 325-1043 Fax: (310) 325-1044

Description

3-Phase CMC

Part Number

P57TP50H-332

REV

1

WEIGHT: 90 gms

SHEET: 1 OF 1